

Technical data sheet

90° Magic bend 60 FT

Item number: 6041154



90° bend with quick connector system. For all cable tray types of 60 mm side height.

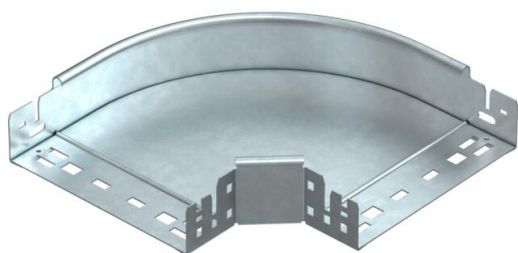

St Steel

FT Hot-dip galvanised

Master data

Item number	6041154
Type	RBM 90 620 FT
Description 1	90° bend
Description 2	with quick connector
Manufacturer	OBO
Dimension	60x200
Material	Steel
Surface	Hot-dip galvanised
Surface standard	DIN EN ISO 1461
Smallest sales unit	1
Unit of quantity	Piece
Weight	131.3 kg
Weight unit	kg/100 pc.

Technical data sheet

90° Magic bend 60 FT

Item number: 6041154



Dimensions

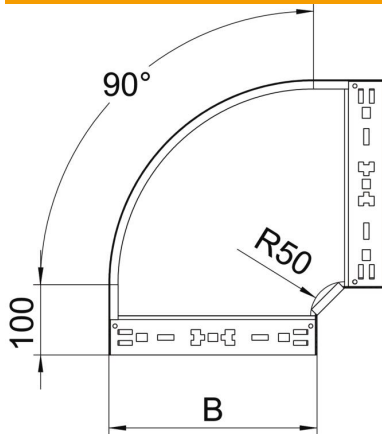

Width	200 mm
Width	8 in
Height	60 mm
Height	2 in
Plate thickness	1.25 mm
Dimension B	200 mm

Technical data

Bend (angle)	90°
Connector version	Integrated connector
Type	Bend, rigid
Maintain electrical functions	yes
Mounting perforation in base	no
NATO hole pattern	no
Change of direction	Horizontal
Rustproof steel, pickled	no
Side perforation	no
Wide-span version	no
Type of connector, cable support system	Click fastening