



Koblingsbokser

X-serie



X-TREME

Den nye X-serien



Ekstrem belastbar

Med X-serien tilbyr OBO Bettermann en rekke koblingsbokser som tåler de sterkeste mekaniske belastningene. Gjennom bruken av spesiell kunststoff basert på polykarbonat oppfyller X-serien med IK09 de høyeste kravene for slagkraftighet. Den høye kvaliteten på X-serien er garantert av testene i henhold til DIN EN 60670 del 1 og 22.

X-serien imponerer ikke bare med sin robusthet, men også med sin funksjonelle og gjennomtenkte design.

Feste av boksene kan gjøres enten ved hjelp av intern, ekstern eller hjørnemontering. Fleksibel tilpasset kravene til den respektive installasjonen. Praktiske tester har vist at spesielt det ekstra høye ledningsområdet er verdsatt av brukerne.

Alt i alt dekker X-serien alle krav som er satt på moderne og praksisorienterte koblingsbokser.

Størrelse variasjoner

X01 95x95x60



X10 190x150x125

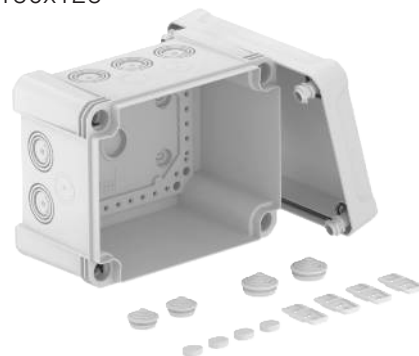

X02 95x95x72



X16 240x191x125



X04 114x114x78



X25 286x202x126

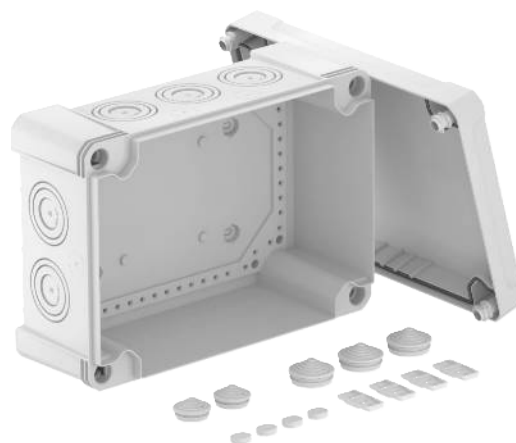

X06 151x167x87



X-serien

Slagfast

Bruken av spesielle kunststoffer basert på polykarbonat av høy kvalitet gjør at X-serien koblingsboks og tomme kabinetter med beskyttelsesklasse IK09 kan tilby spesielt høy slagmotstand. Alle bokser i X-serien er teste iht. DIN EN 60670 del 1 og 22.



Tilpasningsdyktig

Koblingsboksene er testet og godkjent: X-serien har et høyt ledningsområde, samt et enkel og spesielt fleksibelt feste. Koblingsboksene kan etter ønske festes med innvendige, eksterne eller hjørnefester.

Påkrevd

X-serien er tilgjengelig i forskjellige konfigurasjoner. Formon-
terte komplette pakker er tilgjengelig med koblingsstykke,
kabelmuffe, stikk klemmer og kapselskinne.



Tilbehør

Skrudeksel, innstikketning og utvendig feste elementer er
allerede inkludert i koblingsboksene i X-serien. I tillegg tilbyr
X-serien et omfattende utvalg av tilbehør.

For bruk i ubeskyttede utendørsområder anbefaler vi at koblingsboksen beskyttes mot direkte værforhold (som snø, vind, regn eller sol).

Mot til farge

X-serien finnes i mange fargevarianter. Med lysegrå, gjennomsiktige, svarte og røde elementer i forskjellige konstellasjoner kan forskjellige kretser enkelt skille seg fra hverandre.





01 VBS Broschüre X-Serie 2018 / no / 2019/02/04 05:39:46 05:39:47 05:40:03 05:40:13
05:39:46 05:39:47 05:40:03 05:40:13

Mange ulike typer

Koblingsboks - serien fra OBO Bettermann





A-serie: Har holdt seg ung

Klassisk og fortsatt ung: A-serien utmerker seg ved halogenfri, termoplastisk plast og ved et godt sittende lokk og forpregede kabelinnføringer. En beskyttelsesklasse IP55 og praktiske ytre fester, avrunder klassikerens profil.



X-serie: Ekstrem belastbar

X-serien oppfyller alle kravene til moderne koblingsbokser: X-serien koblingsbokser med IK09 har spesielt høy slagfasthet. Samtidig overbeviser koblingsboksene med sin funksjonelle og gjennomtenkte design. Den enkle og fleksible installasjonen, eventuelt med intern, ekstern eller hjørnemontering, overbeviser i den praktiske testen, så vel som det spesielt høye ledningsområdet.



T-serie: Universell

Med høykvalitets materialer, fornuftige veggtykkelser og en stabil konstruksjon, har T-serien intelligens i sine gener. Alle koblingsboksene i T-serien er preget av deres UV-resistente, støtbestandige og halogenfrie materialer og er egnet for bruk innendørs og utendørs.

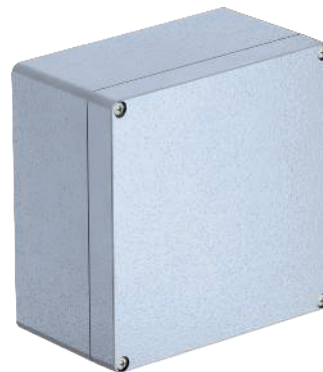





MX-serie: Tøffe typer







De tomme kabinettet i aluminium til MX-serien ble konstruert for bruk under tøffe forhold, og gir optimal beskyttelse av installasjonen. Metallkabinettet tåler ekstremt høye og lave temperaturer og store temperaturforskjeller. Hverken høye støtbelastninger innen industrien, hærverk eller steinsprut kan skade huset.

Typeoversikt

Koblingsboks fargevarianter

				
	lysegrå / lysegrå	lysegrå / gjennomsiktig	grafittsvart / grafittsvart	grafittsvart / rød
X 01	X01 LGR	X01 LGR-TR	X01 SW	X01 SW-RO
X 02	X02 LGR	X02 LGR-TR	X02 SW	X02 SW-RO
X 04	X04 LGR	X04 LGR-TR	X04 SW	X04 SW-RO
X 06	X06 LGR	X06 LGR-TR	X06 SW	X06 SW-RO
X 10	X10 LGR	X10 LGR-TR	X10 SW	X10 SW-RO
X 16	X16 LGR	X16 LGR-TR	X16 SW	X16 SW-RO
X 25	X25 LGR	X25 LGR-TR	X25 SW	X25 SW-RO
X 10	X10 LGR	X10 LGR-TR	X10 SW	X10 SW-RO
X 16	X16 LGR	X16 LGR-TR	X16 SW	X16 SW-RO
X 25	X25 LGR	X25 LGR-TR	X25 SW	X25 SW-RO

Koblingsboks sett

						
	med koblingsstykke	med klemskinne, kabelmuffer og kontramutter	med kabelmuffer og kontramutter	med universalstikklemmer, kabelmuffer og kontramutter	med gjennomsiktig lokk og profilskinne	med koblingsstykke
X 01	X01 T LGR	X01 T G M20 LGR	X01 G M20 LGR	X01 UT G LGR		
X 02	X02 T LGR	X02 T G M20 LGR	X02 G M20 LGR	X02 UT G LGR		
X 04	X04 T LGR	X04 T G M20 LGR	X04 G M20 LGR	X04 UT G LGR		
X 06	X06 T LGR	X06 T G M20 LGR			X06 R LGR-TR	X06 H25 GNP4
X 10	X10 T LGR				X10 R LGR-TR	X10 H25 GNP5
X 16	X16 T LGR				X16 R LGR-TR	X16 H25 GNP5 X16 H35 GNP5
X 25	X25 T LGR				X25 R LGR-TR	X25 H25 GNP5 X25 H35 GNP5

Tom koblingsboks farge variant og sett

					
	lysegrå / lysegrå	lysegrå / gjennomsiktig	grafittsvart / grafittsvart	lysegrå / lysegrå med profilskinne	lysgrå / gjennomsiktig med profilskinne
X 01	X01C LGR	X01C LGR-TR	X01C SW		
X 02	X02C LGR	X02C LGR-TR	X02C SW		
X 04	X04C LGR	X04C LGR-TR	X04C SW		
X 06	X06C LGR	X06C LGR-TR	X06C SW	X06C R LGR	X06C R LGR-TR
X 10	X10C LGR	X10C LGR-TR	X10C SW	X10C R LGR	X10C R LGR-TR
X 16	X16C LGR	X16C LGR-TR	X16C SW	X16C R LGR	X16C R LGR-TR
X 25	X25C LGR	X25C LGR-TR	X25C SW	X25C R LGR	X25C R LGR-TR



X 02
IP67
OBO 700 V
MULTI-MEDIALE
EFL 80070-1 EFL 80071-02

01_VBS-Broschüre_X-Serie_Abfrage-no./2019/02/04-08:39:46 (LTEXp...03:46) / 2019/02/04-08:40:03

Koblingsbokser i X-serien med sving implementering og innstikketting



- Koblingsbokser med støtmotstand IK09 og beskyttelsesklasse IP67 tåler selv tunge mekaniske belastninger
- Av høykvalitets, halogenfri, UV-resistent polykarbonat
- Testet i henhold til DIN EN 60670 Del 1 og 22
- Leveringsomfanget inkluderer skru hette, eksterne festelementer, samt innstikketting

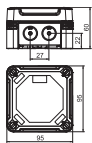

Type

Farge
Innføringer
Mål LxBxH mm
Lysåpning indre mål mm
Forp. Stykk
Vekt kg/100 stk.
Art.-nr.
EI-Nr.

X01 LGR	X01 LGR-TR	X01 SW	X01 SW-RO
lysegrå	grå / gjennomsiktig	grafittsvart	svart / rød
7 x Ø20	7 x Ø20	7 x Ø20	7 x Ø20
95x95x60	95x95x60	95x95x60	95x95x60
85x85x45	85x85x45	85x85x45	85x85x45
1	1	1	1
16,000	16,000	16,000	16,000
2005000	2005050	2005110	2005140
1203751	1203752	1203753	1203754

PC polykarbonat

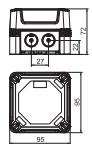

Type

Farge
Innføringer
Mål LxBxH mm
Lysåpning indre mål mm
Forp. Stykk
Vekt kg/100 stk.
Art.-nr.
EI-Nr.

X02 LGR	X02 LGR-TR	X02 SW	X02 SW-RO
lysegrå	grå / gjennomsiktig	grafittsvart	svart / rød
7 x Ø20	7 x Ø20	7 x Ø20	7 x Ø20
95x95x72	95x95x72	95x95x72	95x95x72
85x85x57	85x85x57	85x85x57	85x85x57
1	1	1	1
17,800	17,800	17,800	17,800
2005004	2005054	2005114	2005144
1203755	1203756	1203757	1203758

PC polykarbonat

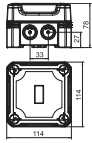

Type	X04 LGR	X04 LGR-TR	X04 SW	X04 SW-RO
Farge	lysegrå	grå / gjennomsiktig	grafittsvart	svart / rød
Innføring	7 x Ø20/25	7 x Ø20/25	7 x Ø20/25	7 x Ø20/25
Mål LxBxH mm	114x114x78	114x114x78	114x114x78	114x114x78
Lysåpning indre mål mm	102x102x60	102x102x60	102x102x60	102x102x60
Forp. Stykk	1	1	1	1
Vekt kg/100 stk.	26,600	26,600	26,600	26,600
Art.-nr.	2005008	2005058	2005118	2005148
EI-Nr.	1203759	1203760	1203761	1203762

PC polykarbonat

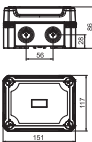

Type	X06 LGR	X06 LGR-TR	X06 SW	X06 SW-RO
Farge	lysegrå	grå / gjennomsiktig	grafittsvart	svart / rød
Innføring	8 x Ø20/25	8 x Ø20/25	8 x Ø20/25	8 x Ø20/25
Mål LxBxH mm	151x167x87	151x167x87	151x167x87	151x167x87
Lysåpning indre mål mm	137x105x68	137x105x68	137x105x68	137x105x68
Forp. Stykk	1	1	1	1
Vekt kg/100 stk.	33,500	33,500	33,500	33,500
Art.-nr.	2005012	2005062	2005122	2005152
EI-Nr.	1203763	1203764	1203765	1203766

PC polykarbonat

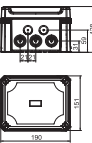
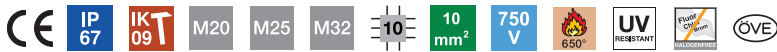

Type	X10 LGR	X10 LGR-TR	X10 SW	X10 SW-RO
Farge	lysegrå	grå / gjennomsiktig	grafittsvart	svart / rød
Innføring	10 x Ø20/25/32	10 x Ø20/25/32	10 x Ø20/25/32	10 x Ø20/25/32
Mål LxBxH mm	191x151x126	191x151x126	191x151x126	191x151x126
Lysåpning indre mål mm	177x137x110	177x137x110	177x137x110	177x137x110
Forp. Stykk	1	1	1	1
Vekt kg/100 stk.	59,200	59,200	59,200	59,200
Art.-nr.	2005016	2005066	2005126	2005156
EI-Nr.	1203767	1203768	1203769	1203770

PC polykarbonat

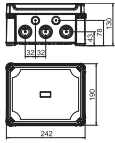
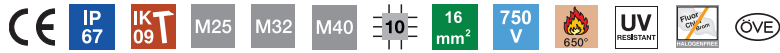

Type

Farge
Innføring
Mål LxBxH mm
Lysåpning indre mål mm
Forp. Stykk
Vekt kg/100 stk.
Art.-nr.
EI-Nr.

X16 LGR	X16 LGR-TR	X16 SW	X16 SW-RO
lysegrå	grå / gjennomsiktig	grafittsvart	svart / rød
10 x Ø25/32/40	10 x Ø25/32/40	10 x Ø25/32/40	10 x Ø25/32/40
241x191x126	241x191x126	241x191x126	241x191x126
227x177x110	227x177x110	227x177x110	227x177x110
1	1	1	1
79,300	79,300	79,300	79,300
2005020	2005070	2005130	2005160
1203771	1203772	1203773	1203774

PC polykarbonat

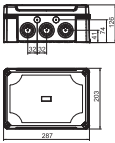
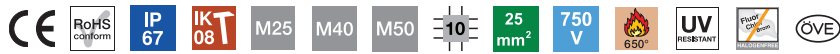

Type

Farge
Innføring
Mål LxBxH mm
Lysåpning indre mål mm
Forp. Stykk
Vekt kg/100 stk.
Art.-nr.
EI-Nr.

X25 LGR	X25 LGR-TR	X25 SW	X25 SW-RO
lysegrå	grå / gjennomsiktig	grafittsvart	svart / rød
10 x Ø25/32/40	10 x Ø25/32/40	10 x Ø25/32/40	10 x Ø25/32/40
286x202x126	286x202x126	286x202x126	286x202x126
271x187x110	271x187x110	271x187x110	271x187x110
1	1	1	1
96,500	96,500	96,500	96,500
2005024	2005074	2005134	2005164
1203775	1203776	1203777	1203778

PC polykarbonat

Koblingsboks i X-serien med sving implementering og kabelmuffer



- Koblingsbokser med støtmotstand IK09 og beskyttelsesklasse IP67 tåler selv tunge mekaniske belastninger
- Av høykvalitets, halogenfri, UV-resistent polykarbonat
- Testet i henhold til DIN EN 60670 Del 1 og 22
- Leveringsomfanget inkluderer skru hette, eksterne feste elementer innstikketning, samt tre kabelnipler V-TEC M20 med passende kontra mutter



Type	Farge	Innføringer	Forp. Stykk	Vekt kg/100 stk.	Art.-nr.	Ei-Nr.
X01 G M20 LGR	lysegrå	7 x Ø20	1	19,000	2005030	1203779

PC polykarbonat

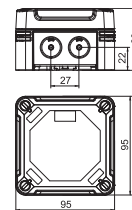

Mål

Type	Mål LxBxH mm	Innvendig mål mm
X01 G M20 LGR	95x95x60	85x85x45



Type	Farge	Innføringer	Forp. Stykk	Vekt kg/100 stk.	Art.-nr.	Ei-Nr.
X02 G M20 LGR	lysegrå	7 x Ø20	1	21,500	2005032	1203780

PC polykarbonat

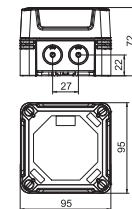

Mål

Type	Mål LxBxH mm	Innvendig mål mm
X02 G M20 LGR	95x95x72	85x85x57



Type	Farge	Innføringer	Forp. Stykk	Vekt kg/100 stk.	Art.-nr.	Ei-Nr.
X04 G M20 LGR	lysegrå	7 x Ø20/25	1	31,400	2005034	1203781

PC polykarbonat

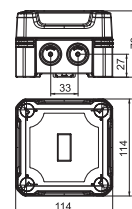

Mål

Type	Mål LxBxH mm	Innvendig mål mm
X04 G M20 LGR	114x114x78	102x102x60

Koblingsboks i X-serien med svingimplementering og klemskinne



- Koblingsboks med støtmotstand IK09 og beskyttelsesklasse IP67 tåle selv tunge mekaniske belastninger
- Av høykvalitets, halogenfri, UV-resistent polykarbonat
- Testet i henhold til DIN EN 60670 Del 1 og 22
- Leveringsomfanget inkluderer skrueheft, eksterne festelementer innstikketetning, samt en matchet til tverrsnittet klemskinnen

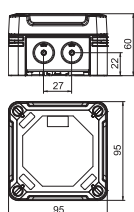

Type	Farge	Innføringer	Forp. Stykk	Vekt kg/100 stk.	Art.-nr.	El-Nr.
X01 T LGR	lysegrå	7 x Ø20	1	17,500	2005190	1203782

PC polykarbonat

Mål

Type	Mål LxBxH mm	Innvendig mål mm
X01 T LGR	95x95x60	85x85x45

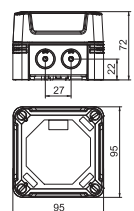

Type	Farge	Innføringer	Forp. Stykk	Vekt kg/100 stk.	Art.-nr.	El-Nr.
X02 T LGR	lysegrå	7 x Ø20	1	19,300	2005194	1203783

PC polykarbonat

Mål

Type	Mål LxBxH mm	Innvendig mål mm
X02 T LGR	95x95x72	85x85x57

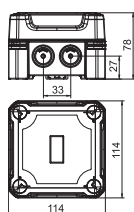

Type	Farge	Innføringer	Forp. Stykk	Vekt kg/100 stk.	Art.-nr.	El-Nr.
X04 T LGR	lysegrå	7 x Ø20/25	1	31,600	2005198	1203784

PC polykarbonat

Mål

Type	Mål LxBxH mm	Innvendig mål mm
X04 T LGR	114x114x78	102x102x60



Type Farge Innføringer Forp. Vekt
 Stykk kg/100 stk. Art-nr. Ei-Nr.
X06 T LGR | lysegrå | 8 x Ø20/25 | 1 | 38,000 | 2005202 | 1203785

PC polykarbonat

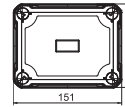
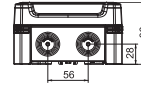

Mål

Type Mål LxBxH mm Innvendig mål mm
X06 T LGR | 151x167x87 | 137x105x68

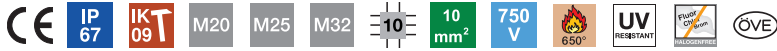

Type Farge Innføringer Forp. Vekt
 Stykk kg/100 stk. Art-nr. Ei-Nr.
X10 T LGR | lysegrå | 10 x Ø20/25/32 | 1 | 72,000 | 2005206 | 1203786

PC polykarbonat

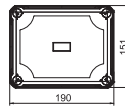
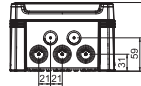

Mål

Type Mål LxBxH mm Innvendig mål mm
X10 T LGR | 191x151x126 | 177x137x110

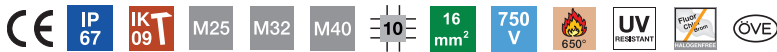

Type Farge Innføringer Forp. Vekt
 Stykk kg/100 stk. Art-nr. Ei-Nr.
X16 T LGR | lysegrå | 10 x Ø25/32/40 | 1 | 97,500 | 2005210 | 1203787

PC polykarbonat

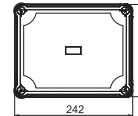
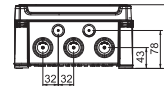

Mål

Type Mål LxBxH mm Innvendig mål mm
X16 T LGR | 241x191x126 | 227x177x110

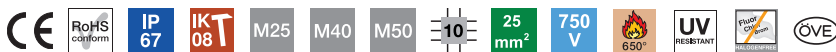

Type Farge Innføringer Forp. Vekt
 Stykk kg/100 stk. Art-nr. Ei-Nr.
X25 T LGR | lysegrå | 10 x Ø25/40/50 | 1 | 130,000 | 2005214 | 1203788

PC polykarbonat

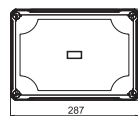
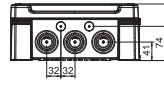

Mål

Type Mål LxBxH mm Innvendig mål mm
X25 T LGR | 286x202x126 | 271x187x110

Koblingsboks i X-serien med svingimplementering, kabel nipler og klemskinne



- Koblingsboks med støttemotstand IK09 og beskyttelsesklasse IP67 tåle selv tunge mekaniske belastninger
- Av høykvalitets, halogenfri, UV-resistent polykarbonat
- Testet i henhold til DIN EN 60670 Del 1 og 22
- Leveringsomfanget inkluderer skru hette, eksterne festelementer innstikktetning, som matcher tverrsnittet til klemskinnen og tre kabel nipler V-TEC M20/M25 med passende kontramutter

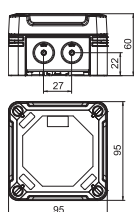

Type	Farge	Innføringer	Forp. Stykk	Vekt kg/100 stk.	Art.-nr.	El-Nr.
X01 T G M20 LGR	lysegrå	7 x Ø20	1	20,500	2005220	1203789

PC polykarbonat

Mål

Type	Mål LxBxH mm	Innvendig mål mm
X01 T G M20 LGR	95x95x60	85x85x45

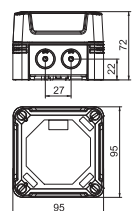

Type	Farge	Innføringer	Forp. Stykk	Vekt kg/100 stk.	Art.-nr.	El-Nr.
X02 T G M20 LGR	lysegrå	7 x Ø20	1	23,000	2005222	1203790

PC polykarbonat

Mål

Type	Mål LxBxH mm	Innvendig mål mm
X02 T G M20 LGR	95x95x72	85x85x57

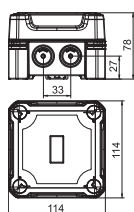

Type	Farge	Innføringer	Forp. Stykk	Vekt kg/100 stk.	Art.-nr.	El-Nr.
X04 T G M25 LGR	lysegrå	7 x Ø20/25	1	36,700	2005224	1203791

PC polykarbonat

Mål

Type	Mål LxBxH mm	Innvendig mål mm
X04 T G M25 LGR	114x114x78	102x102x60



Type	Farge	Innføring	Forp. Stykk	Vekt kg/100 stk.	Art.-nr.	Ei-Nr.
X06 T G M25 LGR	lysegrå	8 x Ø20/25	1	38,000	2005226	1203792
PC polykarbonat						

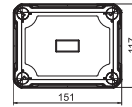
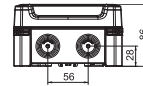

Mål

Type	Mål LxBxH mm	Innvendig mål mm
X06 T G M25 LGR	151x167x87	137x105x68

Koblingsboks i X-serien med svingimplementering, kabel nipler og stikk klemmer



- Koblingsboks med støttemotstand IK09 og beskyttelsesklasse IP67 tåle selv tunge mekaniske belastninger
- Av høykvalitets, halogenfri, UV-resistent polykarbonat
- Testet i henhold til DIN EN 60670 Del 1 og 22
- Leveringsomfanget inkluderer skruehett, eksterne festelementer innstikketetning. I tillegg inkluderer disse kabelforgreningsboksene tre kabel nipler V-TEC og tre stikk klemmer

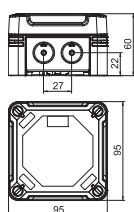

Type	Farge	Innføringer	Forp. Stykk	Vekt kg/100 stk.	Art.-nr.	El-Nr.
X01 UT G LGR	lysegrå	7 x Ø20	1	20,000	2005240	1203793

PC polykarbonat

Mål

Type	Mål LxBxH mm	Innvendig mål mm
X01 UT G LGR	95x95x60	85x85x45

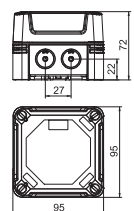

Type	Farge	Innføringer	Forp. Stykk	Vekt kg/100 stk.	Art.-nr.	El-Nr.
X02 UT G LGR	lysegrå	7 x Ø20	1	23,000	2005244	1203794

PC polykarbonat

Mål

Type	Mål LxBxH mm	Innvendig mål mm
X02 UT G LGR	95x95x72	85x85x57

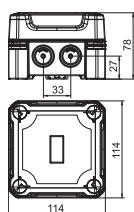

Type	Farge	Innføringer	Forp. Stykk	Vekt kg/100 stk.	Art.-nr.	El-Nr.
X04 UT G LGR	lysegrå	7 x Ø20/25	1	33,500	2005248	1203795

PC polykarbonat

Mål

Type	Mål LxBxH mm	Innvendig mål mm
X04 UT G LGR	114x114x78	102x102x60

Koblingsboks i X-serien med svingimplementering og profilskinne



- Koblingsboks med støtmotstand IK09 og beskyttelsesklasse IP67 tåle selv tunge mekaniske belastninger
- Av høykvalitets, halogenfri, UV-resistent polykarbonat
- Testet i henhold til DIN EN 60670 Del 1 og 22
- Leveringsomfanget inkluderer skru hette, eksterne festelementer innstikkettning, samt et kapselskinnesett bestående av kapselskinne type 2069 og passende festeanordninger



Type	Farge	Innføringer	Forp. Stykk	Vekt kg/100 stk.	Art.-nr.	EI-Nr.
X06 R LGR-TR	grå / gjennomsiktig	8 x Ø20/25	1	37,600	2005092	1203796

PC polykarbonat

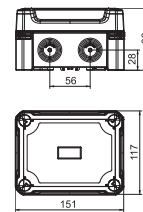

Mål

Type	Mål LxBxH mm	Innvendig mål mm
X06 R LGR-TR	151x167x87	137x105x68

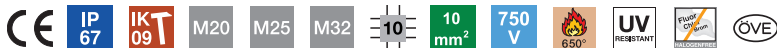

Type	Farge	Innføringer	Forp. Stykk	Vekt kg/100 stk.	Art.-nr.	EI-Nr.
X10 R LGR-TR	grå / gjennomsiktig	10 x Ø20/25/32	1	65,600	2005096	1203797

PC polykarbonat

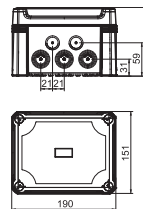

Mål

Type	Mål LxBxH mm	Innvendig mål mm
X10 R LGR-TR	191x151x126	177x137x110

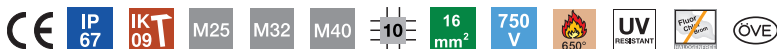

Type	Farge	Innføringer	Forp. Stykk	Vekt kg/100 stk.	Art.-nr.	EI-Nr.
X16 R LGR-TR	grå / gjennomsiktig	10 x Ø25/32/40	1	87,300	2005100	1203798

PC polykarbonat

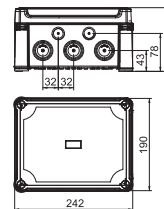

Mål

Type	Mål LxBxH mm	Innvendig mål mm
X16 R LGR-TR	241x191x126	227x177x110



Mål

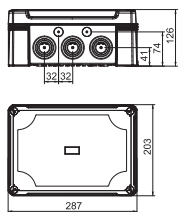

Type	Farge	Innføring	Forp. Stykk	Vekt kg/100 stk.	Art.-nr.	EI-Nr.
X25 R LGR-TR	grå / gjennomsiktig	10 x Ø25/40/50	1	107,000	2005104	1203799

PC polykarbonat

Type	Mål LxBxH mm	Innvendig mål mm
X25 R LGR-TR	286x202x126	271x187x110

Koblingsboks i X-serien med svingimplementering og koblingsklemmer.



- Koblingsbokser med støtmotstand IK09 og beskyttelsesklasse IP67 tåle selv tunge mekaniske belastninger
- Av høykvalitets, halogenfri, UV-resistent polykarbonat
- Testet i henhold til DIN EN 60670 Del 1 og 22
- Leveringsomfanget inkluderer skruehet, eksterne festelementer innstikktetning, samt en formontert kapselskinne for det aktuelle tverrsnittet til det passende koblingsklemmene



Type	Farge	Innføringer	Forp. Stykk	Vekt kg/100 stk.	Art.-nr.	Ei-Nr.
X06 H25 GP4 LGR	lysegrå	8 x Ø20/25	1	56,800	2005304	1203800

PC polykarbonat

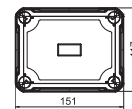
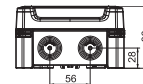

Mål

Type	Mål LxBxH mm	Innvendig mål mm
X06 H25 GP4 LGR	151x167x87	137x105x68

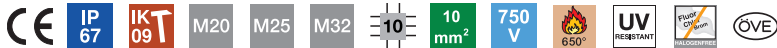

Type	Farge	Innføringer	Forp. Stykk	Vekt kg/100 stk.	Art.-nr.	Ei-Nr.
X10 H25 GNP5 LGR	lysegrå	10 x Ø20/25/32	1	104,000	2005308	1203801

PC polykarbonat

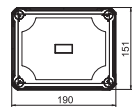
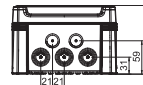

Mål

Type	Mål LxBxH mm	Innvendig mål mm
X10 H25 GNP5 LGR	191x151x126	177x137x110

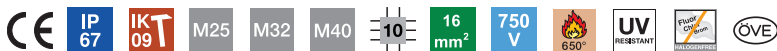

Type	Farge	Innføringer	Forp. Stykk	Vekt kg/100 stk.	Art.-nr.	Ei-Nr.
X16 H25 GNP5 LGR	lysegrå	10 x Ø25/32/40	1	111,000	2005312	1203802
X16 H35 GNP5 LGR	lysegrå	10 x Ø25/32/40	1	125,000	2005316	1203803

PC polykarbonat

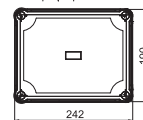
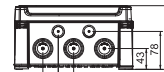

Mål

Type	Mål LxBxH mm	Innvendig mål mm
X16 H25 GNP5 LGR	241x191x126	227x177x110
X16 H35 GNP5 LGR	241x191x126	227x177x110

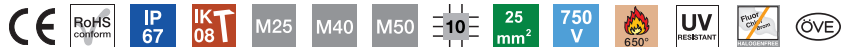
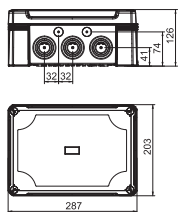

Type	Farge	Innføring	Forp. Stykk	Vekt kg/100 stk.	Art.-nr.	EI-Nr.
X25 H35 GNP5 LGR	lysegrå	10 x Ø25/40/50	1	145,000	2005320	1203804
X25 H50 GNP5 LGR	lysegrå	10 x Ø25/40/50	1	165,000	2005324	1203805

PC polykarbonat

Mål

Type	Mål LxBxH mm	Innvendig mål mm
X25 H35 GNP5 LGR	286x202x126	271x187x110
X25 H50 GNP5 LGR	286x202x126	271x187x110

Tomt kabinett fra X-serien uten innføringer



- Tomt kabinett har ingen introduksjonsåpninger i forhold til koblingsboksen. Disse kan bores individuelt etter behov
- Testet i henhold til DIN EN 60670 Del 1 og 22
- Leveringsomfanget inkluderer skru hette og eksterne festelementer

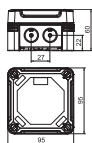

Type	X01C LGR	X01C LGR-TR	X01C SW
Farge	lysegrå	grå / gjennomsiktig	grafittsvart
Mål LxBxH mm	95x95x60	95x95x60	95x95x60
Lysåpning indre mål mm	85x85x45	85x85x45	85x85x45
Forp. Stykk	1	1	1
Vekt kg/100 stk.	15,600	15,600	15,600
Art.-nr.	2005450	2005520	2005590
EI-Nr.	1203806	1203807	1203808

PC polykarbonat

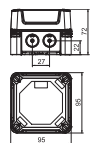

Type	X02C LGR	X02C LGR-TR	X02C SW
Farge	lysegrå	grå / gjennomsiktig	grafittsvart
Mål LxBxH mm	95x95x72	95x95x72	95x95x72
Lysåpning indre mål mm	85x85x57	85x85x57	85x85x57
Forp. Stykk	1	1	1
Vekt kg/100 stk.	17,500	17,500	17,500
Art.-nr.	2005454	2005524	2005594
EI-Nr.	1203809	1203810	1203811

PC polykarbonat

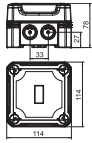

Type

Farge
Mål LxBxH mm
Lysåpning indre mål mm
Forp. Stykk
Vekt kg/100 stk.
Art.-nr.
EI-Nr.

X04C LGR	X04C LGR-TR	X04C SW
lysegrå	grå / gjennomsiktig	grafittsvart
114x114x78	114x114x78	114x114x78
102x102x60	102x102x60	102x102x60
1	1	1
26,300	26,300	26,300
2005458	2005528	2005598
1203812	1203813	1203814

PC polykarbonat

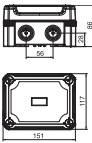

Type

Farge
Mål LxBxH mm
Lysåpning indre mål mm
Forp. Stykk
Vekt kg/100 stk.
Art.-nr.
EI-Nr.

X06C LGR	X06C LGR-TR	X06C SW
lysegrå	grå / gjennomsiktig	grafittsvart
151x167x87	151x167x87	151x167x87
137x105x68	137x105x68	137x105x68
1	1	1
33,100	33,100	33,500
2005462	2005532	2005602
1203815	1203816	1203817

PC polykarbonat

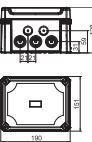

Type

Farge
Mål LxBxH mm
Lysåpning indre mål mm
Forp. Stykk
Vekt kg/100 stk.
Art.-nr.
EI-Nr.

X10C LGR	X10C LGR-TR	X10C SW
lysegrå	grå / gjennomsiktig	grafittsvart
191x151x126	191x151x126	191x151x126
177x137x110	177x137x110	177x137x110
1	1	1
58,500	85,500	58,500
2005466	2005536	2005606
1203818	1203819	1203820

PC polykarbonat

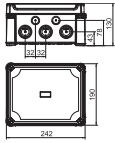

Type	X16C LGR	X16C LGR-TR	X16C SW
Farge	lysegrå	grå / gjennomsiktig	grafittsvart
Mål LxBxH mm	241x191x126	241x191x126	241x191x126
Lysåpning indre mål mm	227x177x110	227x177x110	227x177x110
Forp. Stykk	1	1	1
Vekt kg/100 stk.	78,400	78,400	78,400
Art.-nr.	2005470	2005540	2005610
EI-Nr.	1203821	1203822	1203823

PC polykarbonat

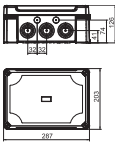

Type	X25C LGR	X25C LGR-TR	X25C SW
Farge	lysegrå	grå / gjennomsiktig	grafittsvart
Mål LxBxH mm	286x202x126	286x202x126	286x202x126
Lysåpning indre mål mm	271x187x110	271x187x110	271x187x110
Forp. Stykk	1	1	1
Vekt kg/100 stk.	95,000	95,000	95,000
Art.-nr.	2005474	2005544	2005614
EI-Nr.	1203824	1203825	1203826

PC polykarbonat

Tomkoblingsboks fra X-serien uten innføringer og profilskinne



- Tom koblingsboks har ingen introduksjonsåpninger. Disse kan bores individuelt etter behov
- Testet i henhold til DIN EN 60670 Del 1 og 22
- Leveringsomfanget inkluderer nedre skru hette, og utvendig festelementer, samt et kapselskinnesett bestående av kapselskinne type 2069 og passende festeanordninger

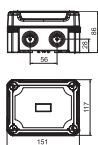

Type

Farge
Mål LxBxH mm
Lysåpning indre mål mm
Forp. Stykk
Vekt kg/100 stk.
Art.-nr.
EI-Nr.

X06C R LGR

lysegrå
151x167x87
137x105x68
1
37,600
2005490
1203827

X06C R LGR-TR

grå / gjennomsiktig
151x167x87
137x105x68
1
37,600
2005560
1203828

PC polykarbonat

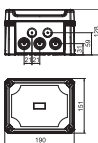

Type

Farge
Mål LxBxH mm
Lysåpning indre mål mm
Forp. Stykk
Vekt kg/100 stk.
Art.-nr.
EI-Nr.

X10C R LGR

lysegrå
191x151x126
177x137x110
1
65,600
2005494
1203829

X10C R LGR-TR

grå / gjennomsiktig
191x151x126
177x137x110
1
65,600
2005564
1203830

PC polykarbonat

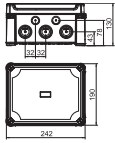

Type	X16C R LGR	X16C R LGR-TR
Farge	lysegrå	grå / gjennomsiktig
Mål LxBxH mm	241x191x126	241x191x126
Lysåpning indre mål mm	227x177x110	227x177x110
Forp. Stykk	1	1
Vekt kg/100 stk.	87,300	87,300
Art.-nr.	2005498	2005568
EI-Nr.	1203831	1203832

PC polykarbonat

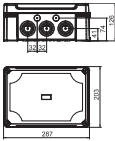

Type	X25C R LGR	X25C R LGR-TR
Farge	lysegrå	grå / gjennomsiktig
Mål LxBxH mm	286x202x126	286x202x126
Lysåpning indre mål mm	271x187x110	271x187x110
Forp. Stykk	1	1
Vekt kg/100 stk.	107,000	107,000
Art.-nr.	2005502	2005572
EI-Nr.	1203833	1203834

PC polykarbonat

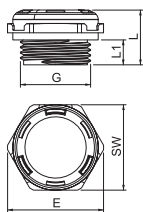

Type	Gjenger	Beskyttelsesklasse	Farge	Forp. Stykk	Vekt kg/100 stk.	Art.-nr.	EI-Nr.
109 M20 LGR	M20x1,5	IP68	lysegrå	5	0,538	2034680	1203835

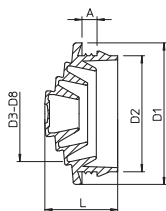

Type	Størrelse	for Ø	Farge	Forp. Stykk	Vekt kg/100 stk.	Art.-nr.	EI-Nr.
EDS M20 LGR	M20	0 - 17	lysegrå	100	0,125	2012350	1217287
EDS M25 LGR	M25	0 - 22	lysegrå	100	0,185	2012354	1217288
EDS M32 LGR	M32	0 - 28	lysegrå	50	0,295	2012358	1217289

PE Polyetylen

Klemskinne 2,5 mm², kabelforgreningsboks A-serie

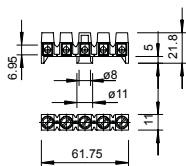

Type	Farge	Antall klemmepunkter	Merke-tverrsnitt mm ²	Merke-spenning V	Forp. Stykk	Vekt kg/100 stk.	Art.-nr.	EI-Nr.
689	lysegrå	5	0,8 - 2,5	660	50	1,502	2017342	1203836

PA polyamid

Klemmens hovedelement forniklet messing, skruer stål, galvanisert og transparent passivert, merketverrsnitt 0,8 - 2,5 mm², merkespenning 660 V, 5-polet, med bøssingklemme, maks. tverrsnitt som kan tilkobles per klemmepunkt: 4 x 2,5 mm², 5 x 1,5 mm² eller 6 x 1 mm², ekstra poler kan utskilles og brukes som enkeltklemmer.

Klemskinne 6 mm², kabelforgreningsboks T-serie

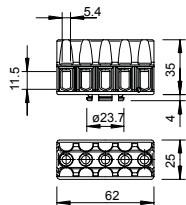

Type	Farge	Antall klemmepunkter	Merke-tverrsnitt mm ²	Merke-spenning V	Forp. Stykk	Vekt kg/100 stk.	Art.-nr.	EI-Nr.
KL-T 02-06	lysegrå	5	1,5 - 6	400	10	4,380	2016185	1215692

PA polyamid

Klemmens hovedelement og skruer av stål, galvanisert og transparent passivert, merketverrsnitt 1,5 - 6 mm², merkespenning 400 V, 5-polet, med bøssingklemmer maks. tverrsnitt som kan tilkobles per klemmepunkt: 3 x 6 mm², 4 x 4 mm² eller 6 x 2,5 mm².

Klemskinne 16 mm², kabelforgreningsboks T-serie

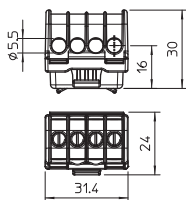

Type	Farge	Antall klemmepunkter	Merke-tverrsnitt mm ²	Merke-spenning V	Forp. Stykk	Vekt kg/100 stk.	Art.-nr.	EI-Nr.
KL-T 06-16	lysegrå	4	6 - 16	400	10	1,970	2016190	1203837

PA polyamid

Klemmer messing, skruer stål, galvanisert og transparent passivert, merketverrsnitt 6 - 16 mm², merkespenning 400 V, 1-polet, med bøssingklemmer maks. ledere som kan tilkobles per klemmepunkt maks. 4x16 mm², 4x10 mm² 8x6 mm² eller 12x4 mm².

Klemskinne 35 mm², kabelforgreningsboks T-serie



Type	Farge	Antall klemmepunkter	Merke-tverrsnitt mm ²	Merke-spenning V	Forp. Stykk	Vekt kg/100 stk.	Art.-nr.	EI-Nr.
KL-T 16-35	lysegrå	4	16 - 35	400	10	5,630	2016195	1203838

PA polyamid

Klemmer messing, skruer stål, galvanisert og transparent passivert, merketverrsnitt 16 - 35 mm², merkespenning 400 V, 1-polet, med bøssingklemmer maks. ledere som kan tilkobles per klemmepunkt maks. 4x35 mm², 4x25 mm² 8x16 mm² eller 12x10 mm².

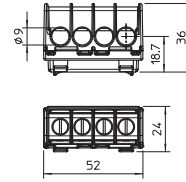

Type	Merke-tverrsnitt mm ²	Polantall	Antall klemsteder per pol	Forp. Stykk	Vekt kg/100 stk.	Art.-nr.	EI-Nr.
KL-X10 06-16	6 - 16	5	4	1	17,600	2008931	1203839
KL-X16 06-16	6 - 16	5	4	1	14,500	2008935	1215692
KL-X25 16-35	16 - 35	5	4	1	37,500	2008939	1203840

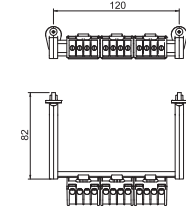

Type	Maks. ledertverrsnitt mm ²	Polantall	Antall klemsteder per pol	Forp. Stykk	Vekt kg/100 stk.	Art.-nr.	EI-Nr.
Hlak 4-8x16	25	4	4	1	19,200	2009032	1203841

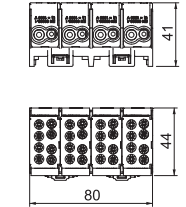

Type	Maks. ledertverrsnitt mm ²	Polantall	Antall klemsteder per pol	Forp. Stykk	Vekt kg/100 stk.	Art.-nr.	EI-Nr.
Hlak 5-10x16	25	4	5	1	23,100	2009036	1203842

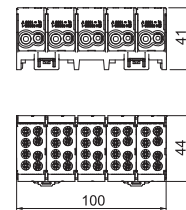

Type	Maks. ledertverrsnitt mm ²	Polantall	Antall klemsteder per pol	Forp. Stykk	Vekt kg/100 stk.	Art.-nr.	EI-Nr.
Hlak 5-10x25	35	4	5	1	38,100	2009038	1203843

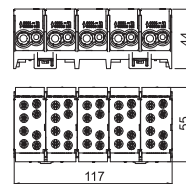

Type	Maks. ledertverrsnitt mm ²	Polantall	Antall klemsteder per pol	Forp. Stykk	Vekt kg/100 stk.	Art.-nr.	EI-Nr.
Hlak 1-2x35 GR	70	4	1	1	11,600	2009042	1203844
Hlak 1-2x35 GRGN	70	4	1	1	11,600	2009044	1203845
Hlak 1-2x35 GRBL	70	4	1	1	11,600	2009046	1203846

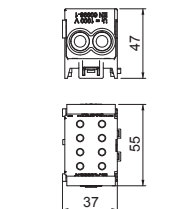

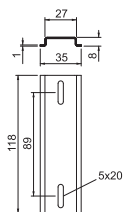

Type	Lengde	Bredde	Høyde	Forp. Vekt		Art.-nr.	Ei-Nr.
	mm	mm	mm	Stykk	kg/100 stk.		
2069 X06 FS	118	35	8	1	4,300	1115876	1203847
2069 X10 FS	161	62	23	1	7,400	1115879	1203848
2069 X16 FS	211	62	23	1	9,200	1115882	1203849
2069 X25 FS	252	62	23	1	10,700	1115887	1203850

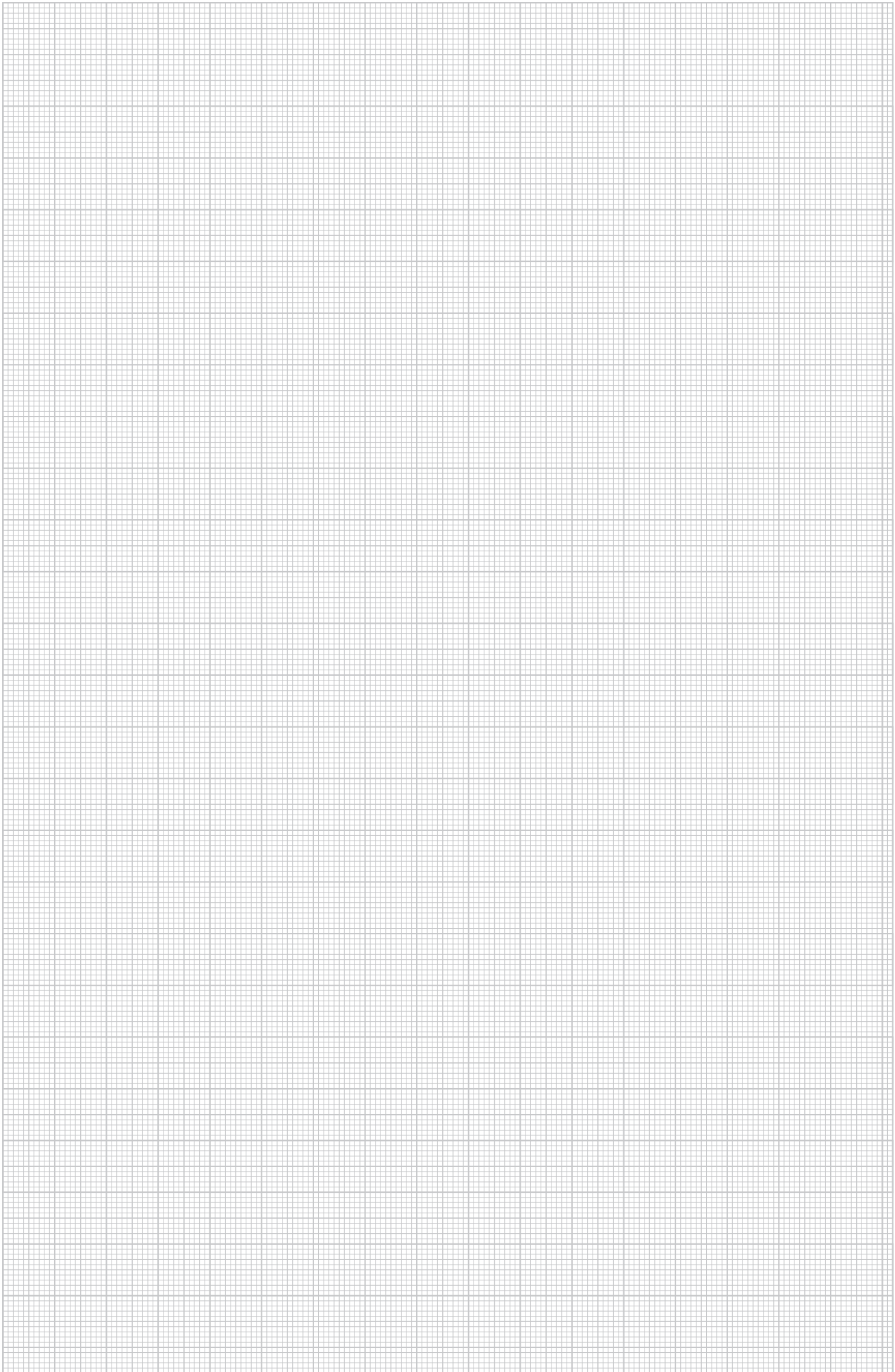

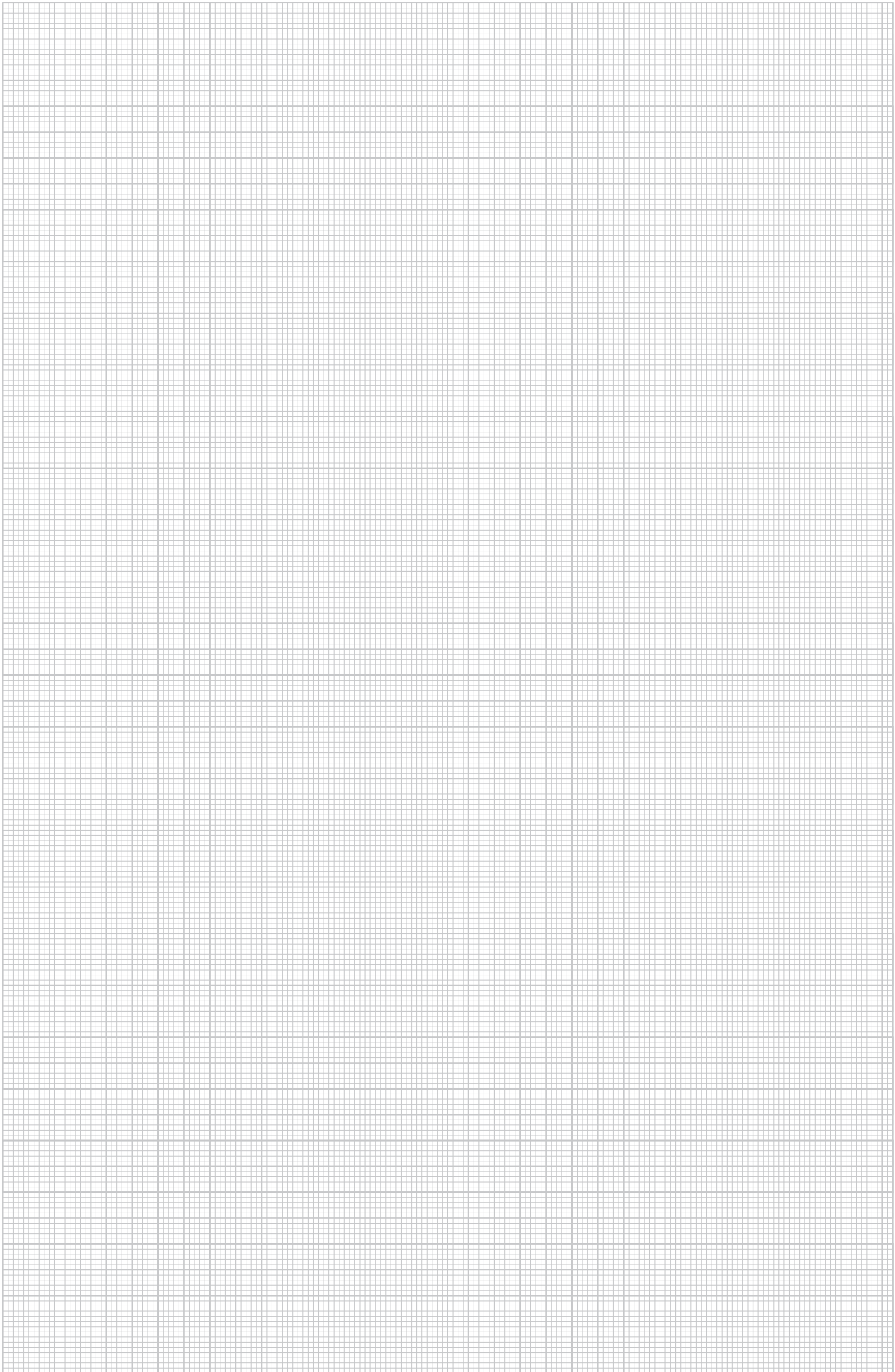

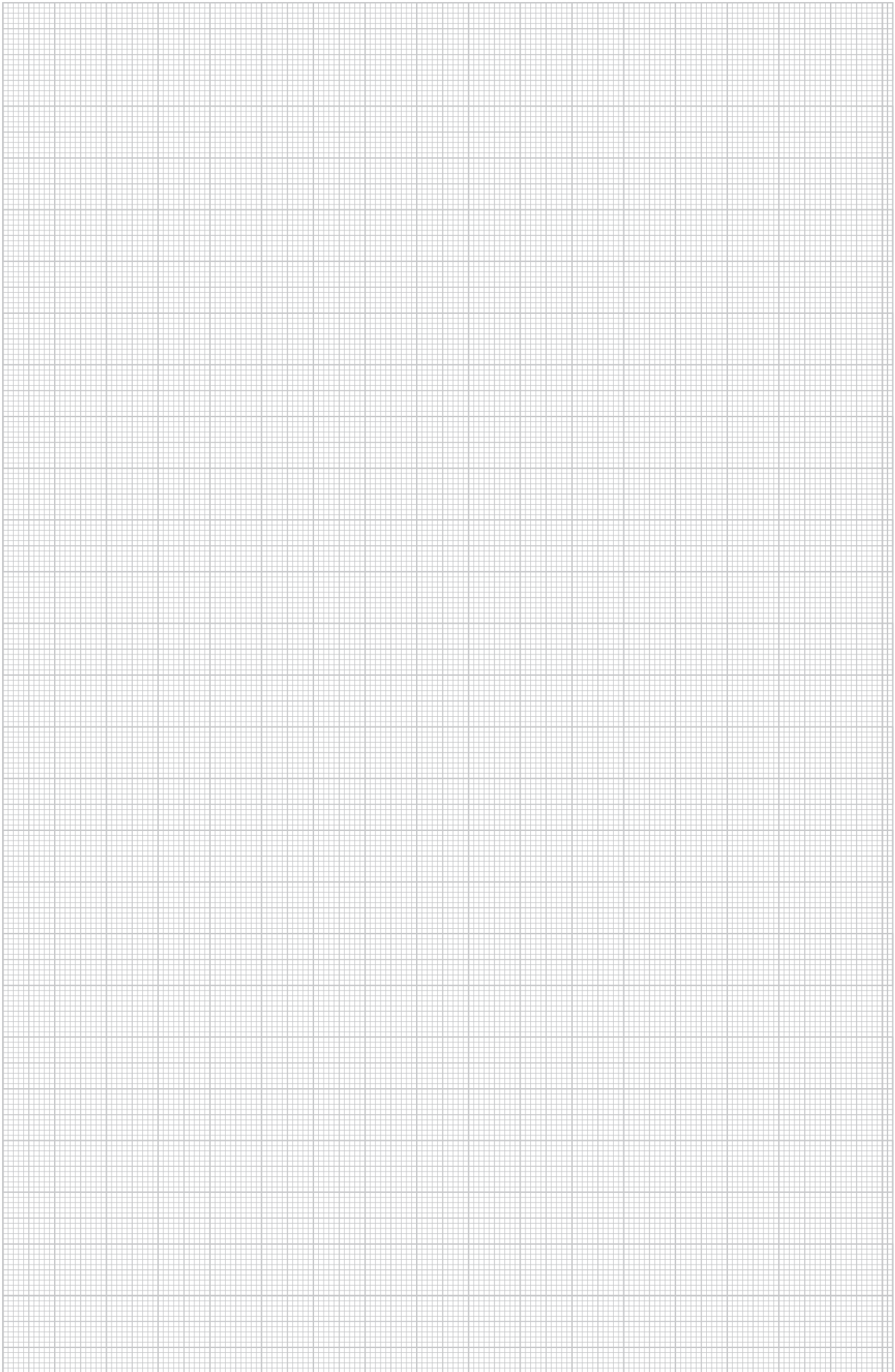

OBO Bettermann AS
Hvamveien 4
2013 Skjetten

Kundeservice Norge.
Faks: +49 23 71 78 99 – 25 00
info@obo-bettermann.no

www.obo-bettermann.no

Building Connections

